

catalogue

grande distribution



bmmanutention.fr







sommaire



échelle cuisson
haute température



échelle
boulangerie - Pâtisserie - Boucherie



Chariot bac



grilles à carton
«Poubelle»



manutention

Délai **24h** livraison par **Chronopost**

Roue & Roulette
haute température





Echelle cuisson



UNIQUE SUR LE MARCHÉ
liaison mécanique au centre du caoutchouc

Gomme

› roulement à billes spéciaux

CODE					
RHT80	80	30	12	40	100
RHT100	100	30	12	40	120



confort dans son usage







Haute résistance
contre les chocs thermiques

roue **silencieuse**
amortissement des chocs

ne **MARQUE PAS** les sols

› **gomme**
roulement à billes spéciaux



Pivotante							
IRHT80	80	30	100x85	80x60	108	40	100
IRHT100	100	30	100x85	80x60	128	42	120

Galet Ø 80, 100mm
Roue gomme roulement à billes
Dureté du bandage 72 Shore A
Température d'emploi : -40°C +260°C



Résine phénolique

Galet Ø 80, 100mm
 Résine phénolique bague spéciale inox téflon
 Galet Ø 80, 100mm
 Résine phénolique roulement à billes
 Dureté du bandage 90 Shore D
 Température d'emploi : -40°C +280°C



› bague spéciale inox téflon

CODE					
------	--	--	--	--	--

27027B	80	35	12	40	170
27031B	100	35	12	40	170

Chape platine inox avec joint spécial cristalline (spécial haute température)







› résine phénolique bague spéciale inox téflon

Pivotante							
27127	80	35	100x85	80x60	108	40	140
27131	100	35	100x85	80x60	128	42	160

Résine phénolique

› roulement à billes







CODE					
------	---	---	---	---	---

GALHT80	80	35	12	40	170
GALHT100	100	35	12	40	170



Chape platine inox avec joint spécial cristalline (spécial haute température)

› résine phénolique
roulement à billes spéciaux

Pivotante							
28127	80	35	100x85	80x60	108	40	140
28131	100	35	100x85	80x60	128	42	160



◀ *Sur demande*
Chape à oeil inox

Ensemble de 4 vis inox

HTVISM820I





échelle

Boulangerie / Pâtisserie / Boucherie



Chape zinguée

Pivotante



Pivotante à blocage total

› Galet moyeu lisse







Pivotante	Pivotante à blocage total	 mm	 mm	 mm	 kg	 mm	 mm
1BBAJKA	2GGAJKA	10,5	100	32	90	132	40
1BBAJLA	2GGAJLA	10,5	125	32	100	158	40
1BANJBU	2GGBJBU	12,8	100	32	90	132	40
1BBNJLA	2GGBJLA	12,8	125	32	100	158	40

Pivotante



Pivotante à blocage total

› Galet roulement à billes

Pivotante	Pivotante à blocage total	 mm	 mm	 mm	 kg	 mm	 mm
1BAAPT B	2GGAPT B	10,5	100	32	90	132	40
1BBAPUB	2GJAPUB	10,5	125	32	100	158	40
1BANPT B	2GGBPT B	12,8	100	32	90	132	40
1BBNPUB	2GJB PUB	12,8	125	32	100	158	40

Galet Ø 100, 125mm
 Bandage en caoutchouc thermoplastique gris non-tâchant
 Jante polypropylène
 Axe boulonné
 Monture en acier embouti finition zinguée
 Pivot sur double rangée de billes
 Pivotante
 Pivotante à blocage total

Existe en blocage directionnel à oeil

*Ajouter le code de la fixation au code de la roulette



FIXATION

Tube rond	CODE
18-20	D10
21-23	D11
24-27	D12
28-31	D13
31-35	D14



FIXATION

Tube carré	CODE
18-20	D50
21-23	D51
24-27	D52
28-31	D53
31-35	D54
36-40	D55

AUTRES DIMENSIONS SUR DEMANDE

bmmanutention.fr





Chape inox

Pivotante



Pivotante à blocage total

› Galet moyeu lisse





Pivotante	Pivotante à blocage total	 mm	 mm	 mm	 kg	 mm	 mm
1A70JKX	2GHOJKX	10,5	100	32	90	132	40
1LNBJAT	2LRBJAT	10,5	125	32	100	158	40
1A74JBT	2GH4JBT	12,8	100	32	90	132	40
1LNGJCQ	2LRGJCQ	12,8	125	32	100	158	40

Pivotante



Pivotante à blocage total

› Galet roulement à billes inox

Pivotante	Pivotante à blocage total	 mm	 mm	 mm	 kg	 mm	 mm
1A70PTL	2GH0PTL	10,5	100	32	90	132	40
1LNBPUL	2LRBPUL	10,5	125	32	100	158	40
1A74PTL	2GH4PTL	12,8	100	32	90	132	40
1LNGPUL	2LRGPUL	12,8	125	32	100	158	40

Galet Ø 100, 125mm
 Bandage en caoutchouc thermoplastique gris non-tâchant
 Jante polypropylène
 Axe boulonné
 Monture inox
 Pivot sur double rangée de billes inox
 Pivotante / Pivotante à blocage total

Existe en blocage directionnel à œil

*Ajouter le code de la fixation au code de la roulette



FIXATION

Tube rond	CODE
18-20	D10
21-23	D11
24-27	D12
28-31	D13
31-35	D14



FIXATION

Tube carré	CODE
18-20	D50
21-23	D51
24-27	D52
28-31	D53
31-35	D54
36-40	D55

Chape composite intérieur inox

Pivotante

Pivotante à
blocage total

Pivotante	Pivotante à blocage total						
-----------	---------------------------	---	---	---	---	---	---

1CA20NDT0	2CB20NDT0	10,3	100	32	90	135	33
1JSB0NBT0	2JWB0NBT0	10,3	125	32	100	161	35
1CA60NDT0	2CB60NDT0	12,8	100	32	90	135	33
1JSH0NBT0	2JWH0NBT0	12,8	125	32	100	161	35



FIXATION

Tube rond	CODE
18-20	D10
21-23	D11
24-27	D12
28-31	D13
31-35	D14



FIXATION







Tube carré	CODE
18-20	D50
21-23	D51
24-27	D52
28-31	D53
31-35	D54
36-40	D55



Tube rond	CODE
22	FRC0
22,6	FRA4
23	FRA0
29,5	FRA5



Tube carré	CODE
21,8	FRDA
22,5	FRB0
27,1	FRB5
32,5	FRBA
33,5	FRC5
37,6	FRD0

Pivotante	Pivotante à blocage total						
W5MD	W5ME	18x62	125	32	100	161	40

Galet Ø 100, 125mm

Bandage en caoutchouc thermoplastique gris non-tâchant

Jante polypropylène

Axe INOX

Intérieur tout INOX

Pivotante

Pivotante à blocage total

*Ajouter le code de la fixation au code de la roulette

AUTRES DIMENSIONS SUR DEMANDE

gramanutenction.fr





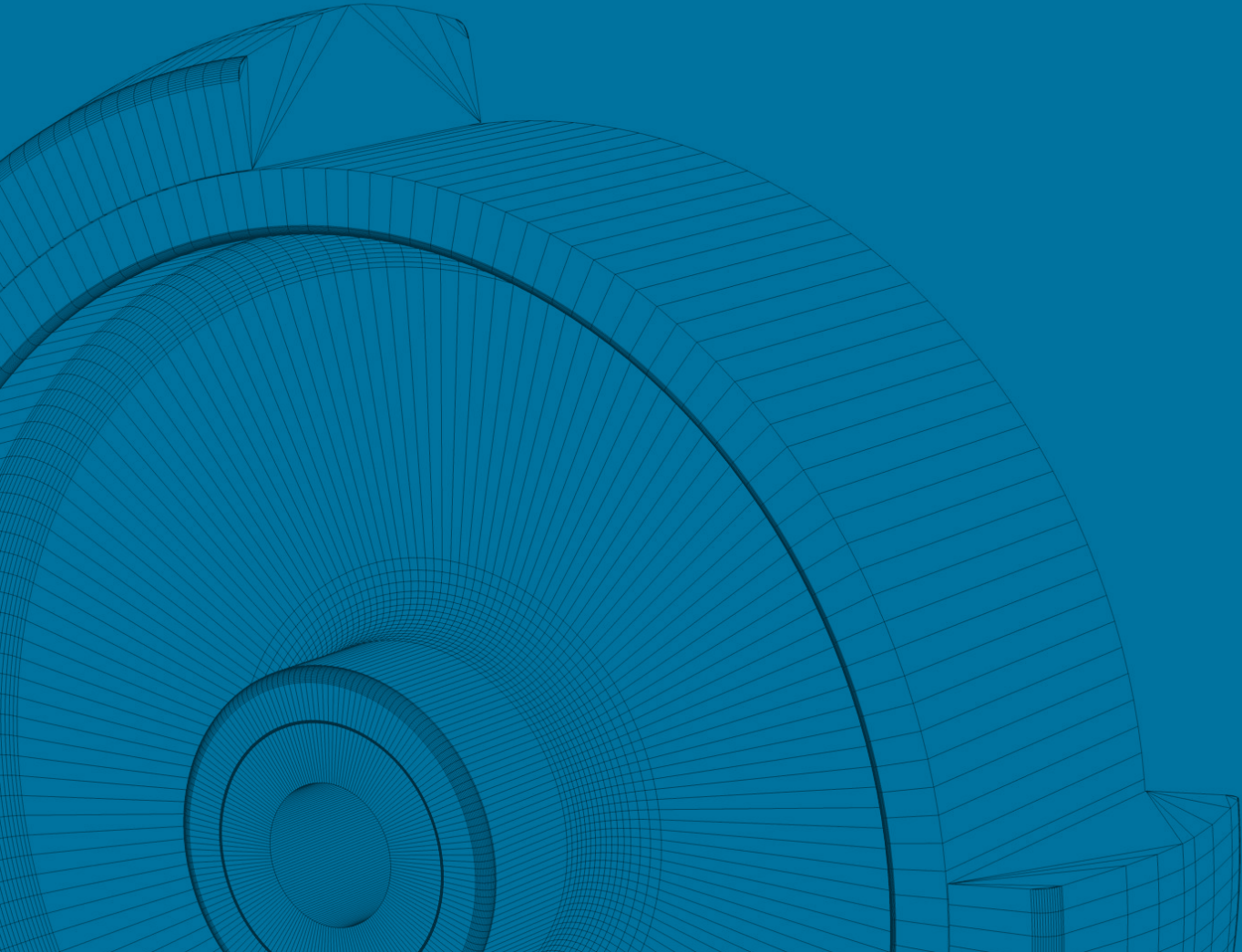

Chariot Bac





Roue polyamide

› lisse







CODE	 mm	 mm	 mm	 mm	 kg
N80L12	80	30	12	40	150
N100L12	100	30	12	40	175
N125L15	125	40	15	44	250
4024	150	40	20	58	350
18092	200	50	20	60	1200
4029	250	60	25	74	1200



› chape platine standard

› lisse



Pivotante	Fixe	Pivotante à blocage total	 mm	 mm	 mm	 mm	 mm	 mm	 kg
17127	17177	17127FR	80	30	100x85	80x60	106	37	150
17130	17180	17130FR	100	30	100x85	80x60	128	37	150
17132	17182	17132FR	125	40	100x85	80x60	155	40	190
17133	17183	17133FR	125	40	140x110	105x80	160	49	250
17136	17186	17136FR	150	40	140x110	105x80	181	51	250
17142	17192	17142FR	200	50	140x110	105x80	235	59	380

AUTRES DIMENSIONS SUR DEMANDE

Roulette en Acier Inoxydable AISI 304 - Dureté 82 Shore A

Bandage polyuréthane élastique bleu corps de roue polyamide 6
Absorption des chocs et grande adhérence sur les surfaces mouillées
Extrêmement résistant aux produits chimiques et nettoyeurs
Matière de qualité alimentaire
Capacité de charge élevée
Disponibles pivotante, pivotante à frein et fixe
Sans entretien

Résistant à la température :
-40°C / +90°C



Caractéristiques :

Roulement rouleaux en acier inoxydable et roulement à billes Inox
Diamètre de roue de 80 à 200 mm

Roue : capacité de charge de 200 à 700 kgs

Roulette : Capacité de charge de 200 à 600 kgs

Lavable à haute pression



Avantages +++

Roue très silencieuse
(amortissement des chocs)

Confort dans son usage





Très résistante à l'usure et à la
corrosion

Facile d'entretien

Polyuréthane injecté - Superlast

Corps de roue polyamide

› roulement à rouleaux inox









CODE	 mm	 mm	 mm	 mm	 kg
PS150RX	100	33	12	45	250
PS151RX	125	35	15	45	300
PS151RX20	125	40	20	58	450
PS152RX	150	40	20	50	350
PS153RX	150	40	20	58	500
PS155RX	200	50	20	58	700



Galet roulement à rouleaux inox
 Galet Ø 100, 125, 150, 175, 200mm
 Bandage polyuréthane bleu corps de roue polyamide 6
 Dureté du bandage 82 Shore A
 Température d'emploi : -40°C + 80°C
 Existe Ø 100 et 125 en 72 Shore A









› roulement à rouleaux inox

Pivotante	Fixe	Pivotante à blocage total	 mm	 mm	 mm	 mm	 mm	 mm	 mm	 kg
35202	35302	35202FR	80	33	100x85	80x60	108	40	200	
35206	35306	35206FR	100	33	100x85	80x60	128	45	220	
35214	35314	35214FR	125	35	100x85	80x60	155	48	230	
35215	35315	35215FR	125	40	140x110	105x80	164	48	250	
35220	35320	35220FR	150	40	100x85	80x60	181	51	250	
35221	35321	35221FR	150	40	140x110	105x80	181	55	300	
35227	35327	35227FR	200	50	140x110	105x80	235	55	300	



› roulement à rouleaux inox

Pivotante	Pivotante à blocage total	 mm	 mm	 mm	 mm	 mm	 kg
35406	35406FR	100	33	12	128	42	220
35415	35415FR	125	35	12	155	44	230
35421	35421FR	150	40	12	181	46	300
35427	35427FR	200	50	12	232	56	300





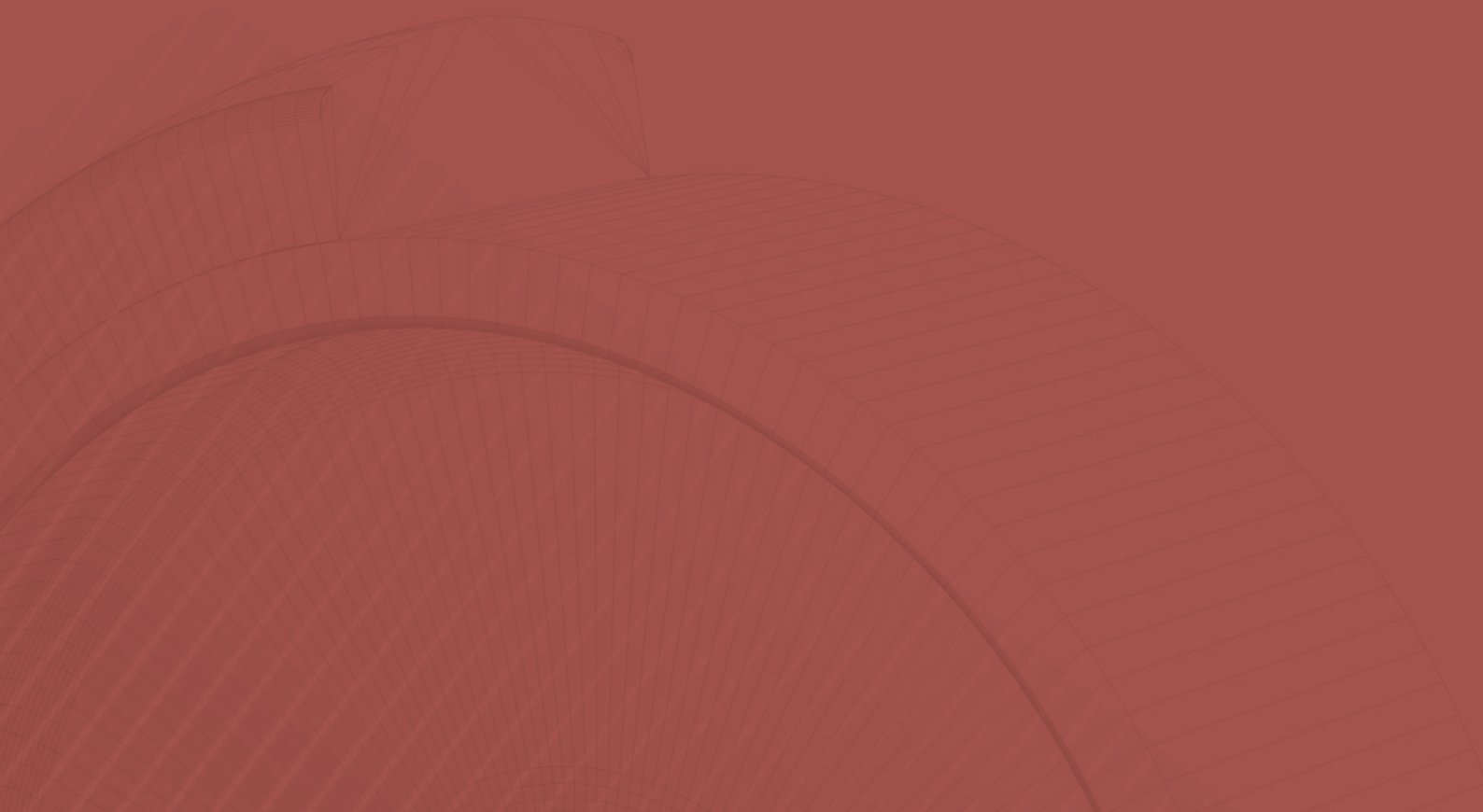

Grilles à cartons « Poubelles »



Caoutchouc noir

Corps de roue thermoplastique

› roulement à rouleaux

CODE					
13078	160	40	20	58	140
13086	200	50	20	58	205









› chape platine standard
› roulement à rouleaux



Frein court
blocage
directionnel

Frein long
blocage
directionnel





Pivotante	Fixe	Pivotante à blocage total	Pivotante à blocage directionnel							
13278	13478	13278FR	13278BD	160	40	140x110	105x80	197	55	140
13286	13486	13286FR	13286BD	200	50	140x110	105x80	235	55	205

Caoutchouc élastique noir

Corps de roue alu

Modèle renforcé

› roulement à billes

CODE					
2005CC	160	50	20	60	300
2009CC	160	50	20	60	450









› roulement à billes



Frein court
blocage
directionnel

Frein long
blocage
directionnel

Pivotante	Fixe	Pivotante à blocage total	Pivotante à blocage directionnel							
16109	16159	16109FR	16109BD	160	50	140x110	105x80	196	56	300
16116	16166	16116FR	16116BD	200	50	140x110	105x80	240	59	300

AUTRES DIMENSIONS SUR DEMANDE

bmmanutention.fr

Transpalette manuels

- > Galets de Fourche polyuréthane
Existe dans toutes les dimensions
et toutes marques sur Stock

- > Galets de Fourche polyamide 6
Existe dans toutes les dimensions
et toutes marques sur Stock

- > Galets de Fourche polyuréthane injecté
Existe dans toutes les dimensions
et toutes marques sur Stock



Roues directrices

- > Alu caoutchouc élastique
Existe dans toutes les dimensions
et toutes marques sur Stock





- > Polyamide 6
Existe dans toutes les dimensions
et toutes marques sur Stock

- > Polyamide 6
caoutchouc élastique
Existe dans toutes les dimensions
et toutes marques sur Stock

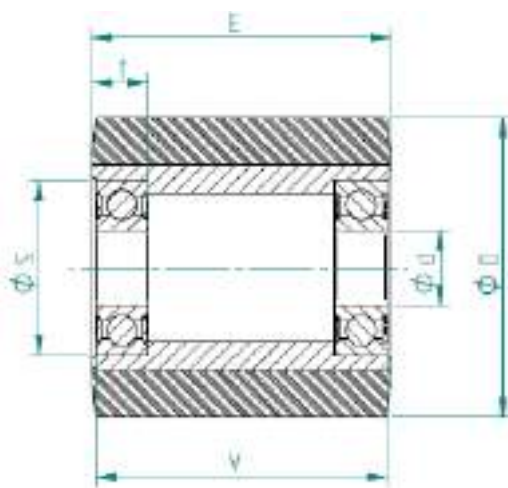





Galet polyuréthane

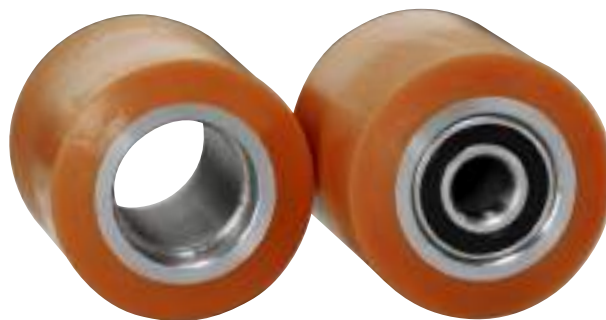

CODE avec roulement	CODE sans roulement				Roulement à billes	
1529CC	1529SC	70	70	15	6202Z	500
1503CC	1503SC	70	100	20	6204Z	650
1506CC	1506SC	75	62	20	6204Z	470
1704CC	1704SC	75	62	25	6204Z	470
1741CC	1741SC	75	75	20	6204Z	570
1528CC	1528SC	75	76	17	6204Z	600
1513CC	1513SC	75	95	20	6204Z	720
1514CC	1514SC	78	78	20	6204Z	750
1515CC	1515SC	80	50	20	6204Z	460
1519CC	1519SC	80	54	20	6005Z	500
1520CC	1520SC	80	54	20	6204Z	500
1664CC	1664SC	80	70	17	6204Z	700
1533CC	1533SC	80	70	20	6204Z	700
1534CC	1534SC	80	80	20	6204Z	800
1535CC	1535SC	80	90	20	6204Z	900
1698CC	1698SC	82	51	25	6205Z	500
1727CC	1727SC	82	58	20	6204Z	580
1522CC	1522SC	82	60	20	6204Z	600
1749CC	1749SC	82	70	17	6303Z	700
1537CC	1537SC	82	70	20	6204Z	700
1680CC	1680CC	82	70	25	6005Z	600
1661CC	1661SC	82	75	20	6204Z	750
1697CC	1697SC	82	78	20	6204Z	780
1713CC	1713SC	82	78	25	6205Z	780

Galet polyuréthane







CODE avec roulement	CODE sans roulement				Roulement à billes	
1726CC	1726SC	82	89	20	6204Z	900
1708CC	1708SC	82	90	20	6204Z	900
1538CC	1538SC	82	100	20	6204Z	1000
1681CC	1681SC	82	100	25	6005Z	1000
1712CC	1712SC	85	40	20	6204Z	400
1739CC	1739SC	85	40	25	6005Z	400
1656CC	1656SC	85	70	17	6303Z	700
1530CC	1530SC	85	70	20	6204Z	700
1592CC	1592SC	85	70	20	6004Z	700
1674CC	1674SC	85	60	20	6204Z	600
1750CC	1750SC	85	62	20	6204Z	610
1703CC	1703SC	85	75	17	6303Z	750
1594CC	1594SC	85	75	20	6204Z	750
1742CC	1742SC	85	75	25	6005Z	750
1746CC	1746SC	85	78	20	6204Z	780
1721CC	1721SC	85	78	25	6205Z	780
1700CC	1700SC	85	80	25	6005Z	800
1531CC	1531SC	85	80	20	6204Z	900
1665CC	1665SC	85	90	17	6303Z	900
1725CC	1725SC	85	90	20	6204Z	900
1740CC	1740SC	85	90	25	6005Z	900
1668CC	1668SC	85	95	20	6204Z	950
1736CC	1736SC	85	100	17	6303Z	1000
1673CC	1673SC	85	100	20	6204Z	1000
1536CC	1536SC	85	100	20	6204Z	1000
1679CC	1679SC	85	110	17	6303Z	1050
1638CC	1638SC	85	110	20	6204Z	1050
1719CC	1719SC	85	110	25	6005Z	1050

Roues directrices







> Alu caoutchouc élastique

CODE					
2007CC	180	50	20	60	350
2008CC	180	50	25	60	350
2009CC	200	50	20	60	450
2010CC	200	50	25	60	450



> Polyamide 6

CODE					
4008	175	50	20	69	500
4005	175	50	25	69	500
4007	200	50	20	63	600
4006	200	50	25	71	600

Axes

Sur demande avec plan

fabrication tout type d'axe > usinage en Interne





Roulement à billes

CODE ORIGINE	CODE	DESIGNATION
6200 2RS	6200 2RS	10x30x9
6201 2RS	6201 2RS	12x32x10
6202 2RS	6202 2RS	15x35x11
6203 2RS	6203 2RS	17x40x12
6004 2RS	6004 2RS	20x42x12
6204 2RS	6204 2RS	20x47x14
6204 ZV	6204 ZV	20x47x12
6205 2RS	6205 2RS	25x52x15
6002 2RS	6002 2RS	15x32x9
6005 ZV	6005 ZV	25x47x12/15
6006 2RS	6006 2RS	30x55x13
6301 2RS	6301 2RS	12x37x12
6302 2RS	6302 2RS	15x42x13
6303 2RS	6303 2RS	17x47x14
6304 2RS	6304 2RS	20x52x15
6305 2RS	6305 2RS	25x62x17
6303 ZV	6303 ZV	17x47x12
6005 2RS	6005 2RS	25x47x14
608 2RS	608 2RS	8x22x7

Roulement à billes inox

CODE ORIGINE	CODE	DESIGNATION
6201 2RS inox	6201 2RS inox	12x32x10
6204 2RS inox	6204 2RS inox	20x47x14
6205 2RS inox	6205 2RS inox	25x52x15

Transpalettes électriques / Gerbeurs

› galets de fourche

Existe dans toutes les dimensions et toutes marques sur Stock



› roues stabilisatrices

Existe dans toutes les dimensions et toutes marques sur Stock



› roues motrices

Existe dans toutes les dimensions et toutes marques sur Stock



Transpalette électriques / Gerbeurs

› galet de fourche



CODE				
V8560312	85	60	12	65
V8580312	85	80	12	85
V8585312	85	85	12	90
V85100312	85	100	12	105
V85105312	85	105	12	110

cache avec joints spéciaux sur galets

V8065320	80	65	20	70
V8085320	80	85	20	90
V8265320	82	65	20	70
V8270320	82	70	20	75
V8280320	82	80	20	85
V8285320	82	85	20	90
V8295320	82	95	20	100
V82100320	82	100	20	105
V8559317	85	59,5	17	61,5
V8560320	85	60	20	65
V8565320	85	65	20	70
V8565317	85	65	17	70
V8569320	85	69	20	71
V8570320	85	70	20	75
V8575317	85	75	17	70
V8575320	85	75	20	80
V8575325	85	75	25	80
V8580317	85	80	17	82
V8580320	85	80	20	85
V8580325	85	80	25	85
V8585320	85	85	20	90
V8585317	85	85	17	90
V8585325	85	85	25	90
V8586317	85	86,5	17	89
V8589320	85	89	20	91
V8590320	85	90	20	95
V8595320	85	95	20	97
BM10100	85	95	20	100
V8595325	85	95	25	97
V8595325J	85	95	25	100
V85100320J	85	100	20	105
V85100325	85	100	25	102
V85105320	85	105	20	110
V85109325	85	109	25	114
V85110325	85	110	25	115

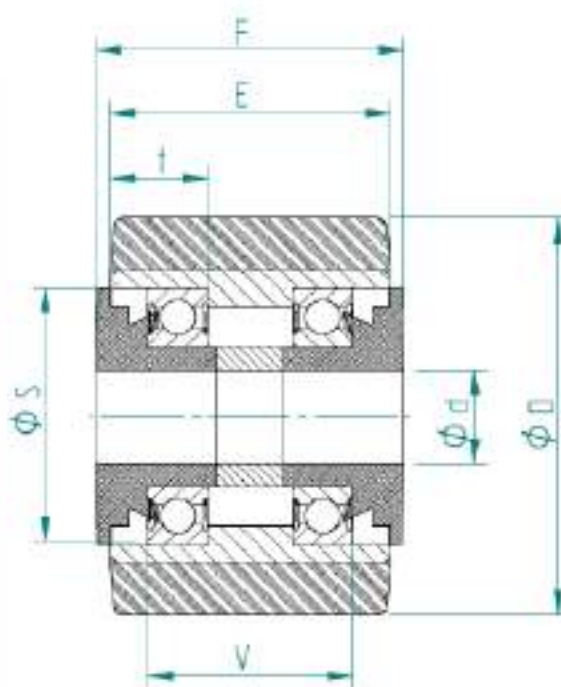



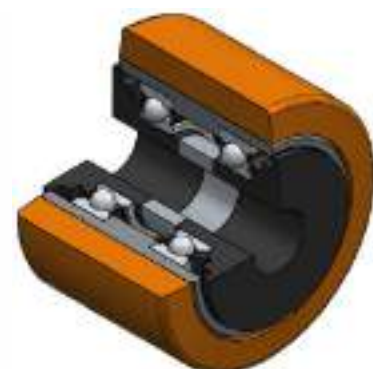

COUPE A-A



Transpalettes électriques / Gerbeurs



› roue stabilisatrice



CODE				
V10040315	100	40	15	40
V12538317	125	38	17	40
V12538315	125	38	15	40
V12540	125	40		40
V12550320F	125	50	20	50
V12550320	125	50	20	55
V12550325	125	50	25	55
V1255020BT	125	50	20	54
V1255832058	125	58	20	58
V1255832054	125	58	20	54
V14054320	140	54	20	60
V15048312	150	48	12	48
V15048320	150	48	20	48
V15050320	150	50	20	55
V15050325	150	50	25	55
V15054320	150	54	20	60
V15054325	150	54	25	60
V15058320	150	58	20	58
V15078325	150	78	25	88
V16050320	160	50	20	55
V16050325	160	50	25	55
V18050320	180	50	20	55
V18050325	180	50	25	60
V18065325	180	65	25	75
V18062325	180	62	25	65
V20050320	200	50	20	55
V2005032555	200	50	25	55
V2005032560	200	50	25	60





Transpalettes électriques

› Roue motrice

CODE			Nombre de trous	Matière
VM230854T	230	85	4	Vulkollan
CM230854T	230	85	4	Caoutchouc
VM230855T	230	85	5	Vulkollan
CM230855T	230	85	5	Caoutchouc
VM230854TC	230	85	4	Vulkollan/cranté
VM250904T	250	90	4	Vulkollan
CM250904T	250	90	4	Caoutchouc



CODE			Nombre de trous	Matière
VF230904T	230	90	4	Vulkollan
VF230905T	230	90	5	
VF2541025T	254	102	5	
CF230904T	230	90	4	Caoutchouc
CF2541025T	254	102	5	
CF230906T	230	90	6	

CODE			Nombre de trous	Matière
JV200854T	200	85	4	Vulkollan
JV230825T	230	82	5	
JV230705T	230	70	5	





Transpalettes électriques

Roue motrice

CODE			Nombre de trous	Matière
VS230755T	230	75	5	Vulkollan
VS250825T	250	82	5	
VS2541025T	254	102	5	
CS2541025T	254	102	5	Caoutchouc
VS20080D	200	80		Vulkollan/denté
CS20080D	200	80		Caoutchouc/denté
PS20080D	200	80		Polyuréthane/denté
ST2501005T	250	100	5	Vulkollan
ST3431367T	343	136	7	



CODE			Nombre de trous	Matière
BC215705T	215	70	5	Caoutchouc
BV215705T	215	70	5	Vulkollan
BV230755T	230	75	5	
BV250755T	250	75	5	
BV2501055T	250	105	5	
BV3101207T	310	120	7	
BV3101105T	310	110	5	

RETRAC

Roue porteuse



Nous consulter avec référence d'origine ou numéro de série

RETRAC

Roue motrice



lexique



Fixation à oeil

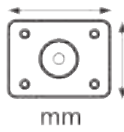

Dimensions de la platine

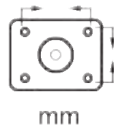

Entraxes de la platine



Ø de roue



Largeur bande de roulement



Charge unitaire



Hauteur totale



Déport



Alésage



Longueur de moyeu



ZAC Pont Peyrin
7 rue du commandant Cousteau

32600 L'ISLE-JOURDAIN



 + 33 (0)5 62 62 08 33

 info@bmmanutention.fr

bmmanutention.fr

